

CVH 500D Circular Knives & Slitting Knives Grinding Machine

CVH 500D
www.eyan.com.tw

CVH 500D
EYAN MACHINE TOOLS CO., LTD.
Circular Knives & Slitting Knives Grinding Machine



Z-axis controlled by servo motor which can set the grinding amount & number of grinding times freely.
Z軸由伺服馬達控制，可自由設定研磨量及研磨次數。



◆ Touch Control panel
觸控控制面板

X-axis controlled by electric motor. X軸由電動馬達控制

◆ Optional Accessories 選購配件



Bowl-Shaped Grinding Wheel
碗型砂輪



Plane grinding wheel
平面砂輪



Patent certificates
專利證書



Grinding Wheel Balance Bar
砂輪平衡桿



Balance Seat
平衡座



Rotary Pneumatic Cylinder
迴轉氣缸

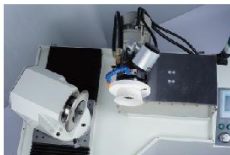

◆ Grinding Samples 研磨產品範例



◆ CVH-500D Specifications 規格表：

Grinding range/circular knife diameter 研磨範圍/圓刀外徑	φ 30 ~ φ 500mm
Swivel angle 研磨刀具角度	± 90°
Knife rotational speed 刀具迴轉速度	175rpm
Z-axis Motor Z軸馬達	AC Servo Motor 伺服馬達
X-axis to and from X軸往復	18mm / Min 分
Actual grinding wheel diameter 使用砂輪直徑	φ 120mm ~ φ 200mm
Grinding wheel inner diameter 砂輪內徑	φ 31.75mm
Grinding wheel motor 砂輪馬達	1.5 kw
Grinding wheel rotation speed 砂輪轉速	1000 ~ 4500rpm
Cooling motor 冷卻馬達	0.13kw
Installation power 安裝電力	2.5kw
Net weight/gross weight 淨重/毛重	1050 / 1193kg
Packing dimensions 裝箱尺寸	148x173x214cm

◆ Standard Accessories 標準配件：

Fully enclosed splash guard 全密式防護罩	1 pc 式
Cooling system 冷卻系統	1 set 組
Blade clamp 刀片夾盤 φ90mm	1 set 組
Working lamp 工作燈	1 set 支
CBN Plane grinding wheel CBN平面砂輪	1 pc 個
Flange 法蘭	1 set 組
Tool box 工具	1 set 組
Lubrication system 強制潤滑系統	1 set 組

◆ Machine Dimensions 機械尺寸圖：

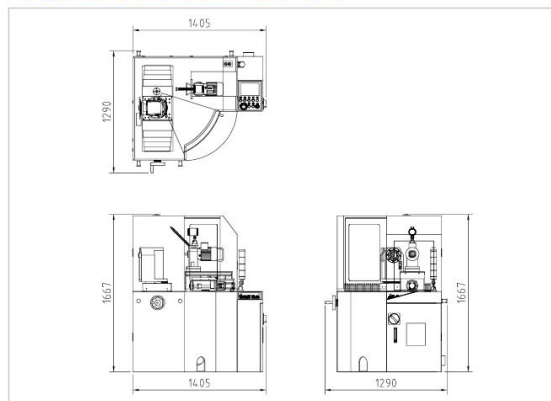

CV 450-A Circular Knives & Slicing Knives Grinding Machine

CV 450-A
www.eyan.com.tw

EVAN MACHINE TOOLS CO., LTD.
Circular Knives & Slicing Knives Grinding Machine

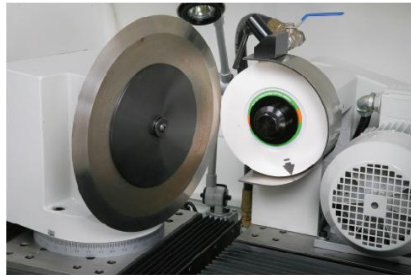

Grinding example of plane grinding wheel
平面砂輪研磨範例

◆ Grinding Examples 研磨例 :

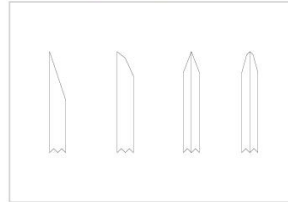

◆ Optional Accessories 選購配件



Flange
法蘭



Grinding Wheel Trim seat
砂輪修整座



◆ Grinding Samples 研磨產品範例

◆ CV-450-A Specifications 規格表 :

Grinding range/circular knife diameter 研磨範圍/圓刀外徑	φ 30 ~ φ 350mm
Swivel angle 研磨刀具角度	± 90°
C-axis cutter circumrotation speed C軸刀具迴轉速度	10 ~ 200rpm (stepless speed change) (無段變速)
Actual grinding wheel diameter 使用砂輪直徑	φ 180 ~ φ 200mm
Grinding wheel inner diameter 砂輪內徑	φ 31.75mm
Grinding wheel motor 砂輪馬達	1.5kw
Grinding wheel rotation speed 砂輪轉速	4200rpm
Cooling motor 冷卻馬達	0.13kw
Installation power 安裝電力	2kw
Net weight/gross weight 淨重/毛重	670 / 790kg
Packing dimensions 裝箱尺寸	142x122x194cm

◆ Standard Accessories 標準配件 :

Fully enclosed splash guard 全密式防護罩	1 pc 式
Cooling system 冷卻系統	1 set 組
Blade clamp 刀片夾盤 φ90mm	1 set 組
Working lamp 工作燈	1 set 支
Plane grinding wheel 平面砂輪	1 pc 個
Flange 法蘭	1 set 組
Tool box 工具	1 set 組
Lubrication system 強制潤滑系統	1 set 組

◆ Machine Dimensions 機械尺寸圖 :

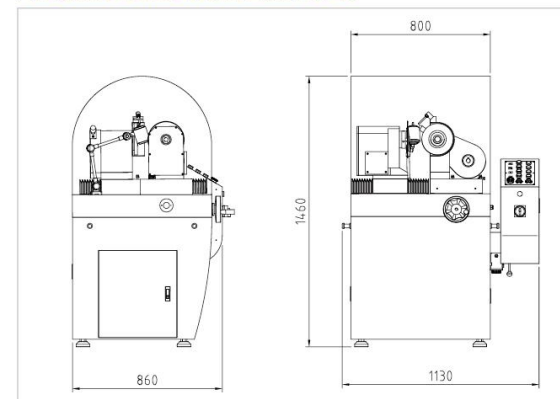

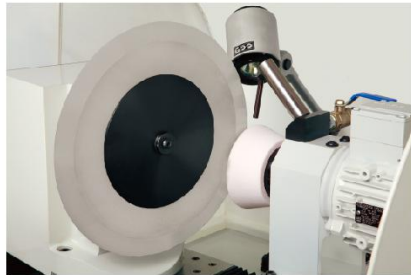

Grinding example of bowl-shaped grinding wheel
碗型砂輪研磨範例

◆ Grinding Examples 研磨例：

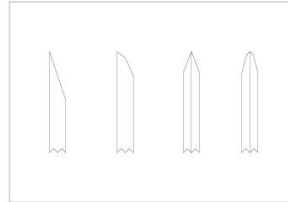

◆ Optional Accessories 選購配件



Flange
法蘭



Grinding Wheel Trim seat
砂輪修整座



◆ Grinding Samples 研磨產品範例

◆ CV-450-B Specifications 規格表：

Grinding range/circular knife diameter 研磨範圍/圓刀外徑	φ 30 ~ φ 350mm
Swivel angle 研磨刀具角度	± 90°
C-axis cutter circumrotation speed C軸刀具迴轉速度	10 ~ 200rpm (stepless speed change) (無段變速)
Actual grinding wheel diameter 使用砂輪直徑	φ 125mm
Grinding wheel inner diameter 砂輪內徑	φ 31.75mm
Grinding wheel motor 砂輪馬達	0.75kw
Grinding wheel rotation speed 砂輪轉速	4200rpm
Cooling motor 冷卻馬達	0.13kw
Installation power 安裝電力	1.5kw
Net weight/gross weight 淨重/毛重	640 / 740kg
Packing dimensions 裝箱尺寸	142x122x194cm

◆ Standard Accessories 標準配件：

Fully enclosed splash guard 全密式防護罩	1 pc 式
Cooling system 冷卻系統	1 set 組
Blade clamp 刀片夾盤 φ90mm	1 set 組
Working lamp 工作燈	1 set 支
Bowl-shaped grinding wheel 碗型砂輪	1 pc 個
Flange 法蘭	1 set 組
Tool box 工具	1 set 組
Lubrication system 強制潤滑系統	1 set 組

◆ Machine Dimensions 機械尺寸圖：

